

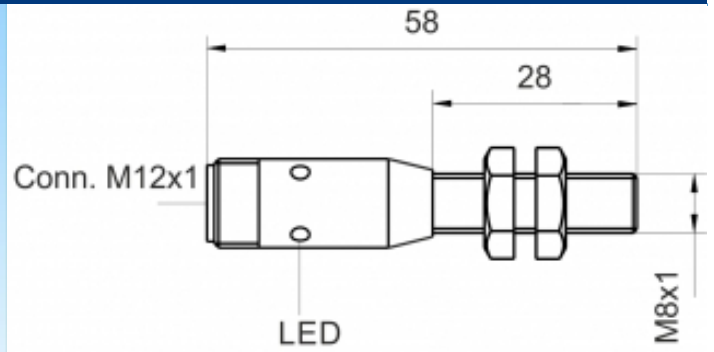

[Article Page](#)

Product Description

inductive sensor DC



Name	KJ2-M8MB58-DPS-V2
Order number	08317811050
Matchcode	9981-1050
Switching distance	2 mm
Mounting	 shielded
Switch type	 N.O.
Signal Type	DC PNP
Connection	connector M12

Connection diagramm

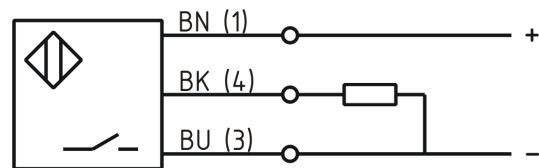

Dimension (in mm)	fine-pitch thread M8 x 58
-------------------	---------------------------

Technical Specification

Operating voltage	10 - 30 VDC
Max. ripple	≤ 10 %
Voltage drop	2,4 V
Max. load current	200 mA
No load current	≤ 13 mA
Leakage current	≤ 10 µA
Switching frequency	3000 Hz
Switching hysteresis	≤ 10 %
Operating temperature	-25 ° C to 70 ° C

Temperature drift	≤ 10 %
Repeat accuracy	≤ 5 %
Swiching state	LED
Short-circuit proof	yes
Overload protection	yes
Reverse voltage protection	yes
Protection category	IP67
EMC-level	DIN EN 60947-5-2: 2008
Housing material	Brass, nickel plated
Material active face	Ultramid B3ZG3
Utilisation category	DC 13
Termination	Connector M12 4pin

Errors and omissions exceptet