

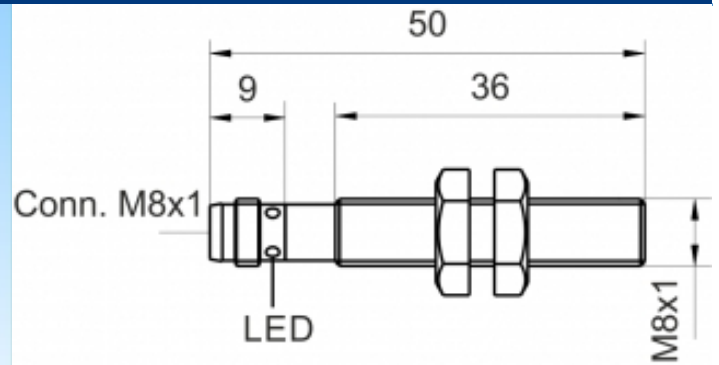

[Article Page](#)

**Product Description**

**inductive sensor DC**

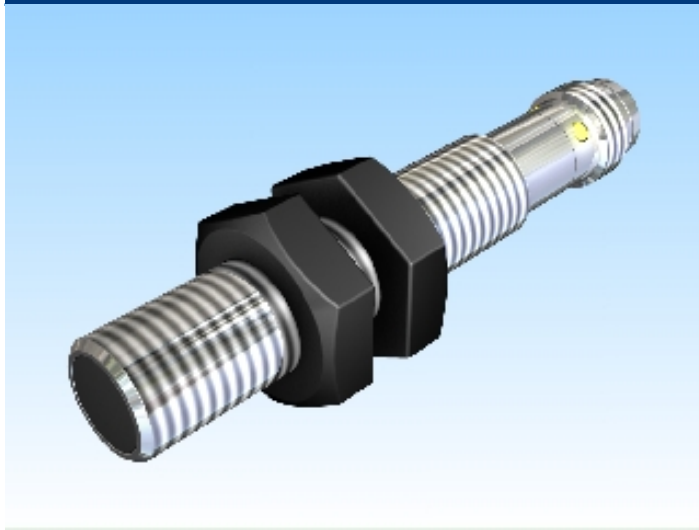

Name	KJ1,5-M8MB50-DPS-V1
Order number	08317610264
Matchcode	9961-0264
Switching distance	1,5 mm
Mounting	 shielded
Switch type	 N.O.
Signal Type	DC PNP
Connection	connector M8

Connection diagramm

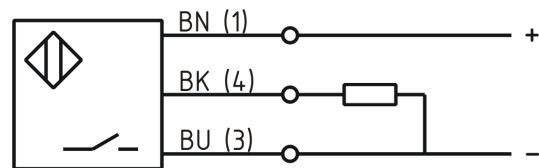

Dimension (in mm)	fine-pitch thread M8 x 50
-------------------	---------------------------

**Technical Specification**

Operating voltage	10 - 30 VDC
Max. ripple	≤ 10 %
Voltage drop	2,4 V
Max. load current	200 mA
No load current	≤ 10 mA
Leakage current	≤ 10 μA
Switching frequency	2000 Hz
Switching hysteresis	≤ 15 %
Operating temperature	-25 ° C to 70 ° C

Temperature drift	≤ 10 %
Repeat accuracy	≤ 5 %
Swiching state	LED
Short-circuit proof	yes
Overload protection	yes
Reverse voltage protection	yes
Protection category	IP67
EMC-level	DIN EN 60947-5-2: 2008
Housing material	Brass, nickel plated
Material active face	ULTRAMID B3ZG3
Utilisation category	DC 13
Termination	Connector M8 3pin

**Errors and omissions exceptet**