

Safety Hinge Switch SHS

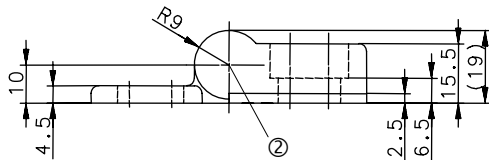
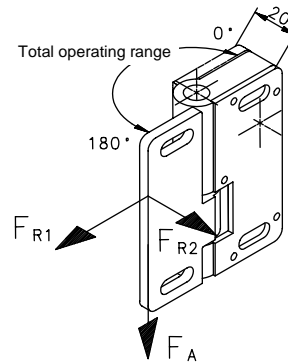
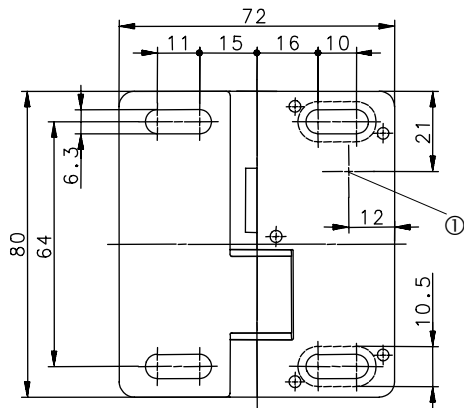
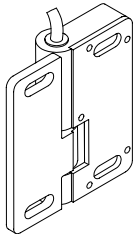

Illustration with fixed shaft and sheared-off set screw.

- ① Position of the connection variants 2, 5 and 6.
- ② Position of the connection variants 1, 3 and 4.

Connection variant 1



Cable, PVC

Connection variant 2

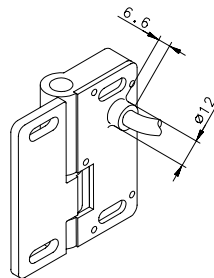

Cable, PVC

Connection variant 3

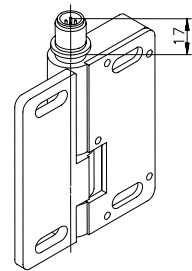

Plug M12x1, metal thread

Connection variant 4

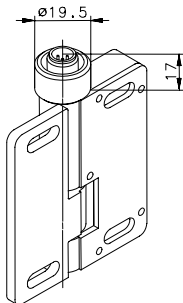

Plug M12x1, metal thread,
with manipulation guard

Connection variant 5

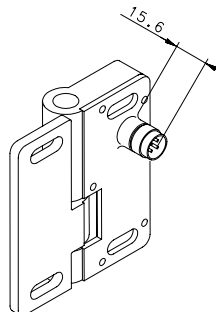

Plug M12x1,
Plastic thread

Connection variant 6

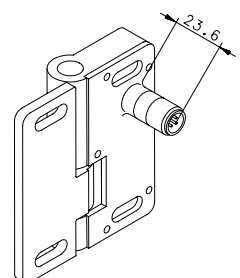

Plug M12x1, metal thread

This document does not form the basis of a contract. The information contained therein does not describe expected properties, thereby excluding the possibility of defect liability arising from any deviations between the actual properties and those described here. We reserve the right to make changes.

Article number	Description	Connection variant	Contact type	Operating diagram	Voltage type	Surface / colour	Protection class	EC-Type Examination Certificate
6019261011	SHS-A1Z-KA 5	1	1 N.C. contact	A	AC/DC	galvanised / blue	I	BG
6019261014	SHS-A1Z-KR 5	2	1 N.C. contact	A	AC/DC	galvanised / blue	I	BG
6119261005	SHS-A1Z-KR 5	2	1 N.C. contact	A	AC/DC	Finish: RAL 9006 (white aluminium)	I	BG
6019261009	SHS-A1Z-SA	3	1 Change over contact	C	AC/DC	galvanised / blue	I	-
6019261010	SHS-A1Z-SR	5	1 Change over contact	B	DC	galvanised / blue	SELV	-
6019261015	SHS-A1Z-SA	3	1 Change over contact	B	DC	galvanised / blue	SELV	-
6019261016	SHS-A1Z-SR	6	1 Change over contact	C	AC/DC	galvanised / blue	I	-
6019261017	SHS-A1Z-SA-BG	4	1 N.C. contact	D	AC/DC	galvanised / blue	I	BG
6019261018	SHS-A1Z-SR-BG	6	1 N.C. contact	D	AC/DC	galvanised / blue	I	BG

Operating diagram

1 N.C. contact
(Form B)

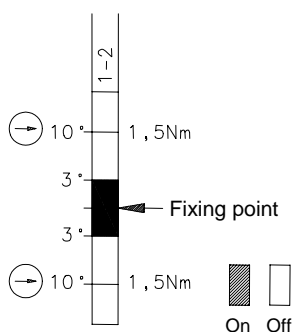

1 Change over contact
(Form C)

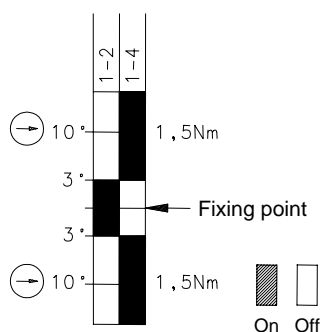

Fixing point in the range 0° ... 180° freely selectable

Tolerance, switching angle (opening) +2,0° / -1,5°

Tolerance, direct opening torque 10 %

Tolerance, direct opening angle +0,5° / -3°

Switching angle hysteresis (closing the N.C. contact -1,0°) from the hinge's typical switch-off point

Circuit diagram

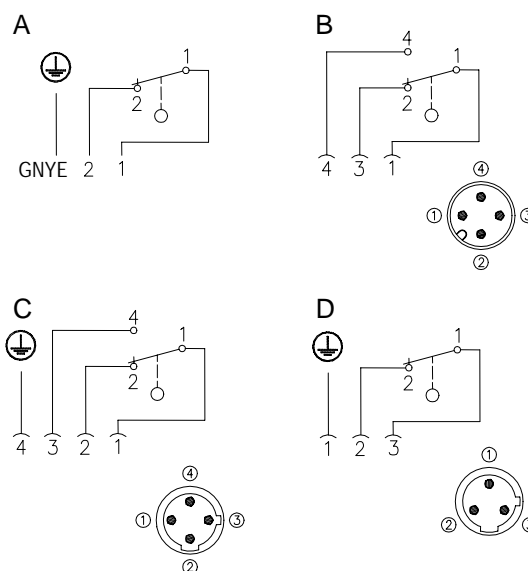



This document does not form the basis of a contract. The information contained therein does not describe expected properties, thereby excluding the possibility of defect liability arising from any deviations between the actual properties and those described here. We reserve the right to make changes.

Technical Data

Safety switches

Common characteristic data

The characteristic data refers to SHS with a fixed switching point.
The data marked also applies to the empty hinges (see Page 4).

Electrical data		
Rated insulation voltage	U_i	250 V
Rated impulse withstand voltage	U_{imp}	2,5 kV
Conv. thermal current	I_{the}	3 A
Rated operational voltage	U_e	230 V AC / 60 V DC
Utilization category		AC-15, 230 V AC / 1,5 A, DC-13, 60 V DC / 0,5 A
Direct opening action		nach IEC/EN 60947-5-1, Anhang K
Short-circuit protection device		fusible link 4 A gL/gG
Mechanical data		
Enclosure	GD-Zn	<input type="checkbox"/>
Cover	GD-Zn	<input type="checkbox"/>
Wing	GD-Zn	<input type="checkbox"/>
Ambient air temperature		-25 °C to +70 °C (cable securely laid) <input type="checkbox"/>
Mechanical life		10 ⁶ operating cycles <input type="checkbox"/>
Switching frequency		Max. 1200 switching operations / hour <input type="checkbox"/>
Attachment		4 x M6 screws DIN 7984 or DIN 6912 <input type="checkbox"/>
Connection type (connection variant 1, 2)		Fixed connecting cable 3 x 0,5 mm ² x 5 m (AWG20) <input type="checkbox"/>
		Minimum bending radius = 25 mm
	(connection variant 3, 4, 5, 6)	M12 plug
Weight		approx. 0,7 kg (variant 1, 2) <input type="checkbox"/>
		approx. 0,4 kg (variant 3, 4, 5 and empty hinge) <input type="checkbox"/>
Installation position		Any <input type="checkbox"/>
Protection type		IP 67 in acc. with IEC/EN 60529
Switching angle		+/- 3 ° from fixing point
Direct opening angle		+/- 10 ° from fixing point
Direct opening torque		1,5 Nm
Mechanical load		F_{R1} = max. 1000 N <input type="checkbox"/>
(see dimensioned drawing for the introduction direction of the forces)		F_{R2} = max. 500 N <input type="checkbox"/>
		F_A = max. 750 N <input type="checkbox"/>
Standards		
		VDE 0660 T100, DIN EN 60947-1, IEC 60947-1
		VDE 0660 T200, DIN EN 60947-5-1, IEC 60947-5-1
EU conformity		
		
Approvals		
		BG (see overview)
		cCSA _{US} C300

This document does not form the basis of a contract. The information contained therein does not describe expected properties, thereby excluding the possibility of defect liability arising from any deviations between the actual properties and those described here.
We reserve the right to make changes.

Notes

The safety fixture must always be attached by at least two SHS! See max. load.

If the risk assessment of the machine permits a single-channel evaluation, an empty hinge (see below) can be used as the support element.

If the SHS is used at an ambient temperature of 70 °C, it is possible that the connecting cable will age more rapidly!

The connecting cable must be protected against mechanical damage.

The cable can be installed in tubes or cable ducts.

The electrical connection for a SHS with BG inspection certificate is only permitted with the following cable couplings (Bernstein range; cable length: 5 m):

3251103234 (with straight plug) or 3251103236 (with angled plug)



In the case of 6019261018, the fastening nut of the connecting cable coupling must be in a closed area after assembly that can only be opened with a tool (manipulation guard; e.g. hollow profile, machine stand, frame,...).

The manufacturer / supplier of the machine / system is obligated to observe the applicable standards for the size of the safety intervals between the separating safety fixture and the hazard point.

These regulations include: EN 294, EN 349, EN 953, EN 1088,

The switch may not be used as a stop.

For a CSA/UL application it is essential to use CSA/UL approved cable for connection versions 3,5 and 6.

The suggested protection type (IP code), referred to the connection variants 3, 4, 5 and 6, applies only when at least an equivalent cable coupling is used.

Empty hinge SHS

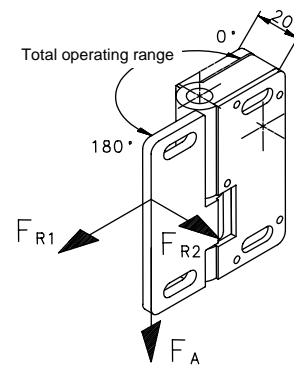
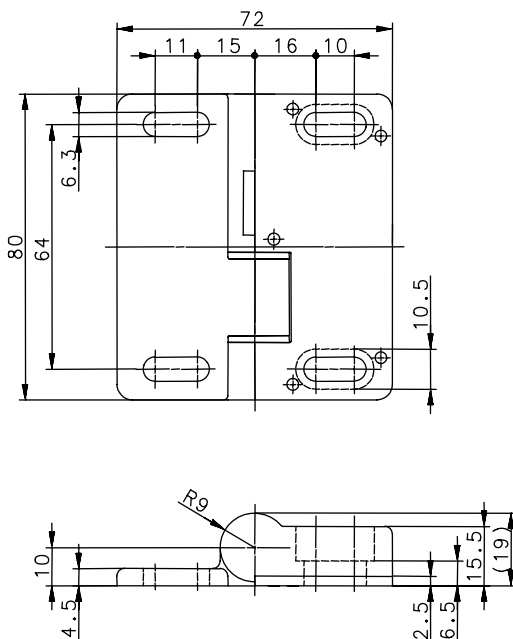

Swivel frequency: max. 1200/hour
Swivel angle: 0° to 180°

Article number	Description	Surface / colour
6019291013	SHS-0Z	Galvanised: blue passivated
6119291006	SHS-0Z -9006-	Finish: RAL 9006 (white aluminium)

The mechanical data corresponds to the safety hinge switches (see Page 3, identification □).

This document does not form the basis of a contract. The information contained therein does not describe expected properties, thereby excluding the possibility of defect liability arising from any deviations between the actual properties and those described here. We reserve the right to make changes.

Date of issue: 21.12.2007 / Page 4 of 4
Document: 7100001_en / Status: 6 / 2801-07